

PROGRAMMABLE LOGIC CONTROLLERS
MELSEC-F
FX Renewal Guide

*Now there is a chance
for renewal!*

FX3 series

Mitsubishi Electric Corporation Himeji Works is a factory certified for ISO 14001 (standards for environmental management systems) and ISO 9001 (standards for quality assurance management systems)

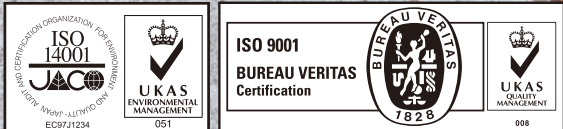

**Empowering
Industries**

The results of 30 years of continued customer support

In 1981 the MELSEC-F series PLC was born.

Since then, thanks to continued customer satisfaction across the globe for more than 30 years, more than 9 million PLCs have been sold.

The MELSEC-F series has continued to evolve with the requirements of the times from the F to FX, and currently the FX3 series. Maintenance requirements for older products of which replacement part production has ceased (7 years after main production is stopped) has increased.

This guide will help to describe the options for renewing older, out of date products with current models. Contact your local representative for an expert opinion.

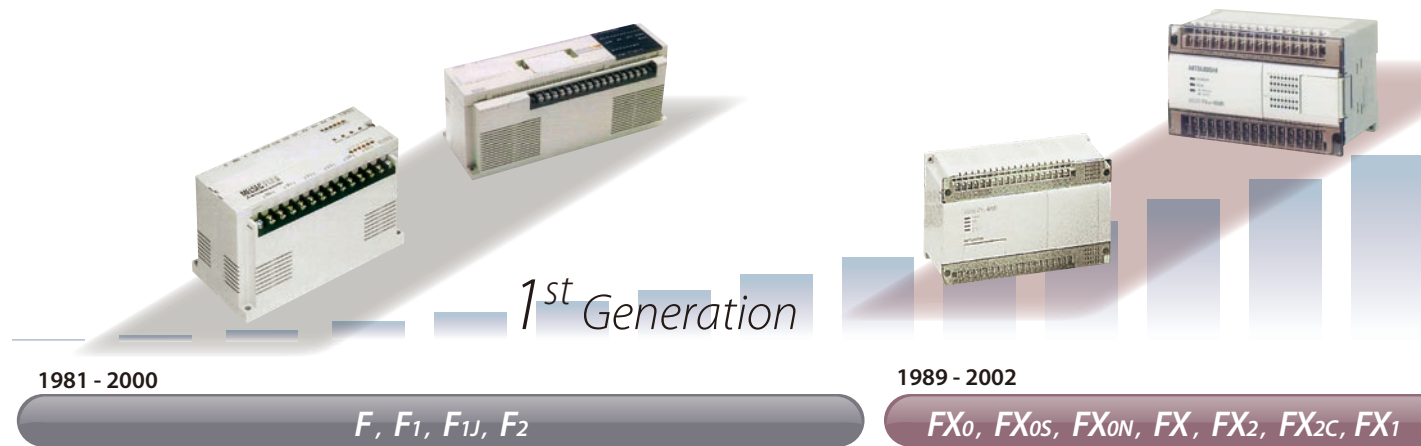

Period for Repair

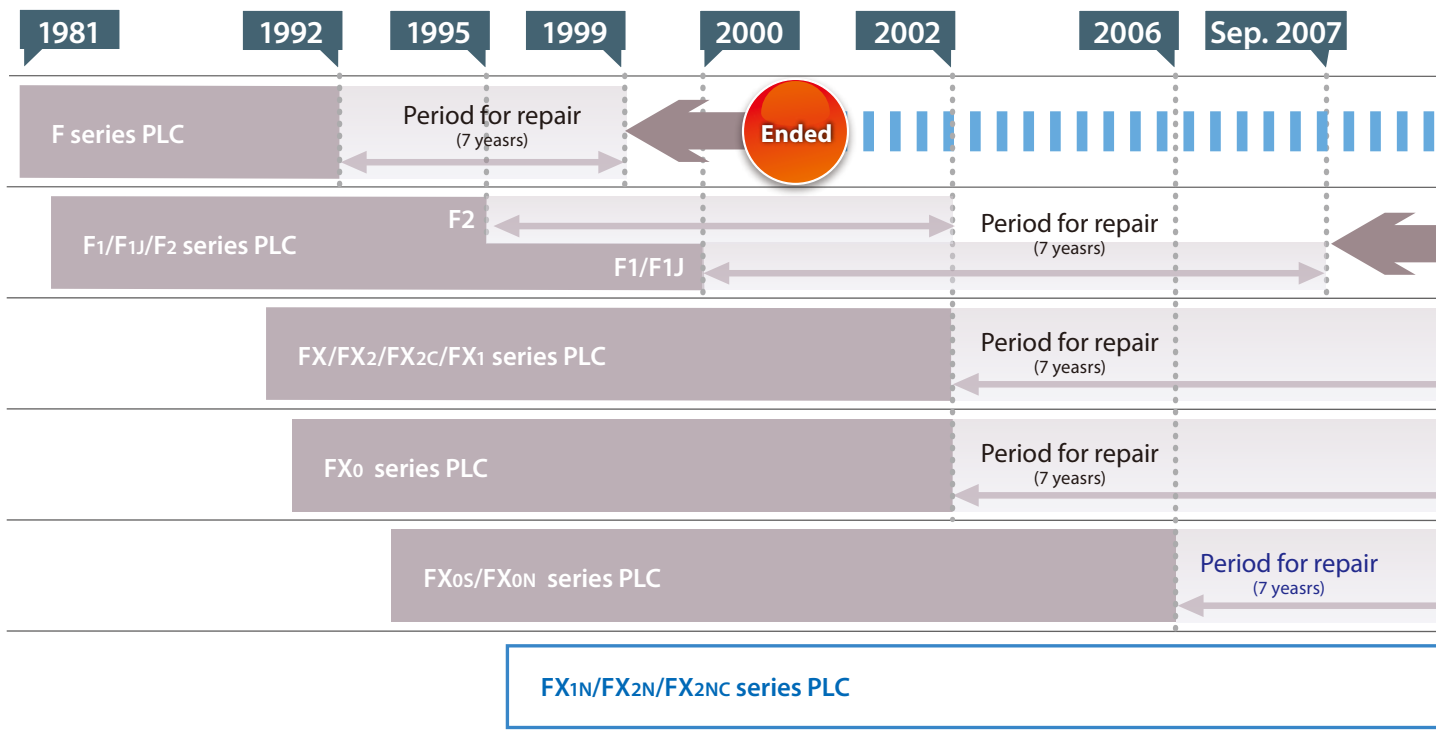



9 million
Total Sales

“Thanks to continued customer satisfaction across the globe for more than 30 years,,



1996 - Now

FX1S, FX1N, FX2N, FX2NC



Now

FX3G, FX3U, FX3UC

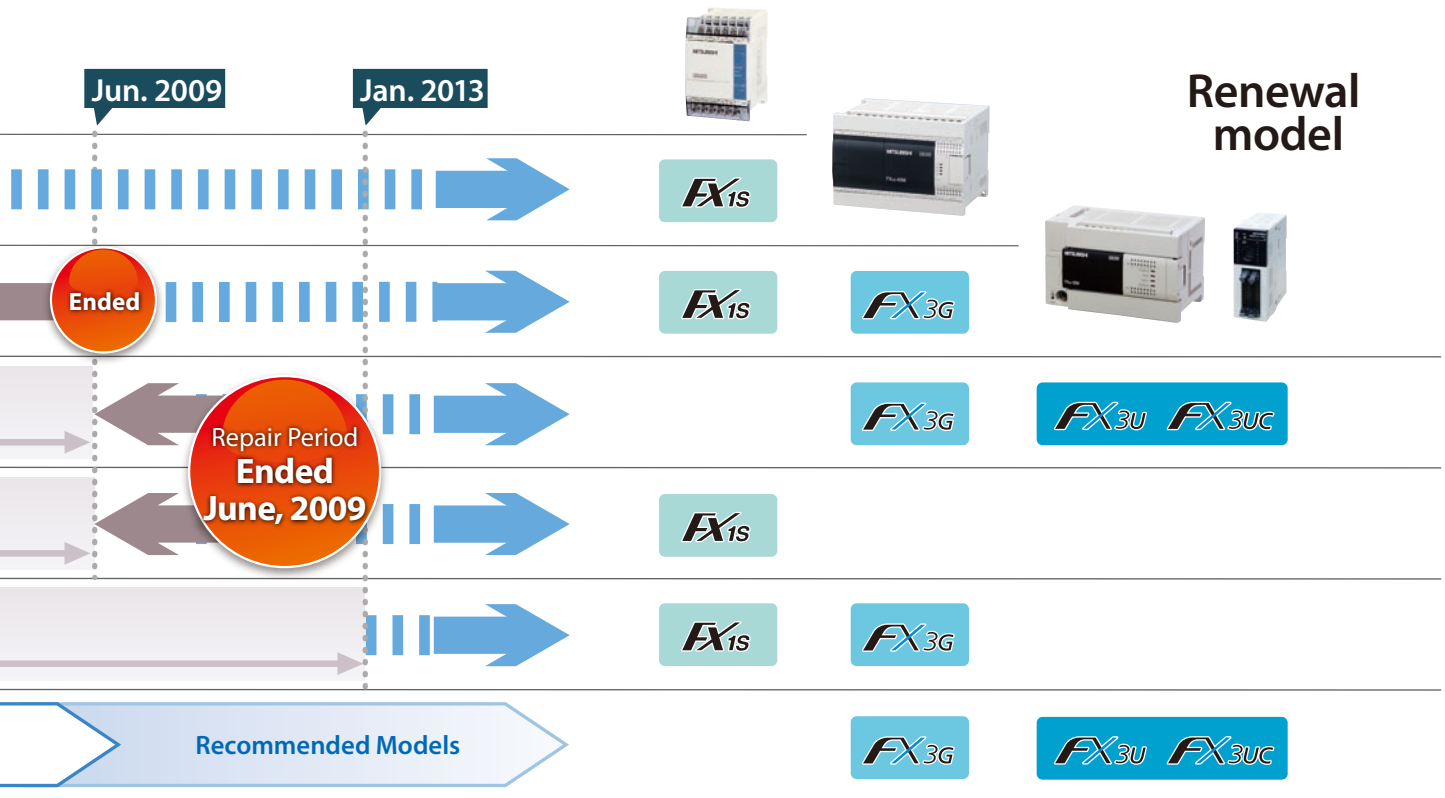



Renewal requirements and benefits

There is now an opportunity to replace old PLCs to prevent lengthy production downtimes during critical production times. Now is the time to prepare for increasing demand.

Renewal Requirements

Product lifespan

Our goal is and always has been to create products with the highest quality possible. However, PLCs are made up of many electronic parts, and while some parts of the PLC may function virtually forever without breaking, other parts (capacitors, relays, switches, batteries, etc.) have finite lifetimes. Although the rest of the PLC may be perfectly capable of functioning, if one part cannot perform its functionality anymore the whole PLC may be affected. Additionally using the PLC in ambient temperatures beyond the recommended 25°C, overloading the contacts, or incorrectly installing the PLC may cause parts to deteriorate faster than normal.

When the product lifespan is shortened due to environmental factors earlier renewal is necessary.

Don't miss the chance to make the best out of a bad economic climate!

Equipment past its lifespan can require frequent maintenance. During an economic downturn this can prove excessively costly. Once the recession is ended the loss from continued production stoppages will become even higher as demand increases. It may not be critical to upgrade equipment now, but now there is an opportunity to taken action now, when production stoppage is less critical, and prepare for the future.

*Please refer to technical news article FA-D-0018-A for details of preventative maintenance of MELSEC PLCs.





Upgrading is easy with Mitsubishi Electric

We at Mitsubishi Electric understand that writing a PLC program is a serious investment and we see the benefit for the customer when previously written programs can be used in new PLCs and S/W as well. Hence our development is not only focused on embedding new technologies and performance into our products, but also on providing our customers products that reinforces the customer's investment and reduces the total cost of ownership. Thanks to this evolutionary design philosophy you can upgrade your PLC system without major changes but still have access to all of today's technologies.

- Various new features and enhanced processing capacity improve production efficiency
- Abundant built-in functions reduce required system dimensions
- Program-less expansion using special adapters increase design flexibility
- The latest generation of GOTs can be connected, allowing for easy maintenance and safer machine operation
- Direct connection and meticulous control of inverters helps reduce energy use
- Up to 3 high-speed outputs with 100 kHz for precise and dynamic servo control
- Connection to open networks such as CC-link, Modbus, or Ethernet increase productivity
- Data logging using the FX3U-CF-ADP (FX3U, FX3UC)
- Programming is simple with PC tools such as GX Developer

Renewal Merits

Steps for renewal

1 Investigation

The first step is to investigate if renewal is necessary or not. Starting with a table of a basic summary of the number of units and functions required. Any remaining drawings, programs, and wiring diagrams help to facilitate this stage.

4 Programming

The original program is inspected to see if it will function in the new PLC. Any expansion devices must also be investigated to ensure compatibility.

2 Diagnosis

A diagnosis is made based on the length of service and the environmental operating conditions. Priority is given to cases with long term use and adverse environments within the exchange timeline.

5 Replacement

The unit replacement is arranged and the new unit is exchanged with the older one.

3 Selection

A replacement model is chosen with consideration given to the included I/O points and any extension I/O points. FX3 series special adapters are a new option that provides various functions with low cost and minimal program changes.

6 Debug

After exchange confirm that the new unit is operating correctly with no errors or timing problems.





Renewal method for each model

Since the amount of available internal devices increases in newer PLCs and the devices are configured in a different way, the renewal method for each model is different. Please use this guide to assist in making a decision for upgrading your PLC.





Peace of mind with the FX Selection Tool

This free tool aids in selecting and checking the FX system configuration. Use this tool to confirm that your renewal system configuration has no conflicts. First select the FX series main unit from the series selection screen.

FX0



FX0N FX0S



Repair Period Ended June, 2009

Repair Period Ends January, 2013



FX3G



FX1S

Renewal method **P10**



Then select the desired main unit type, different options for the power supply, number of I/O points and output format are available.

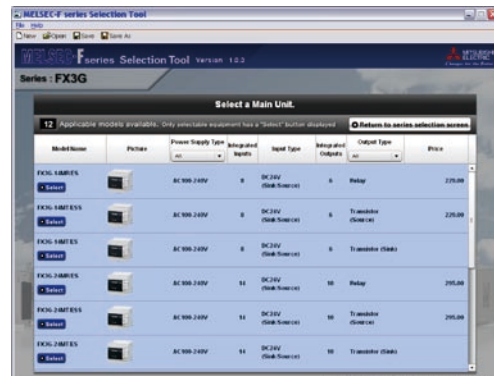

After selecting the main unit, expand you PLC system with all possible options like expansion boards, special function adapters, digital or analog I/O, and special function blocks.



The selection tool provides all important information like power consumption, I/O point alignment and system size. A special page lists all the components in a table and provides the possibility to copy or print the information. Each configuration can be saved for machine ordering or documentation purposes. Please contact your local Mitsubishi Electric representative for more information.



Renewal method for each model



For F1, F1J, F2 series PLC renewal

The following steps will guide you through the renewal process for F1, F1J, and F2 PLCs:

1. Upload program data to the handy programming panel "FX-20P-E" and "FX-20P-E-FKIT".
2. Convert the program, connect to the new PLC, and write the program to the PLC.
3. Upload program data in GX Developer and revise the program.

Note: External dimensions and terminal alignment is differs between PLCs. Make sure to change the wiring and system installation according to the new PLC specifications when upgrading.

Connect to the F1, F1J, F2 series PLC

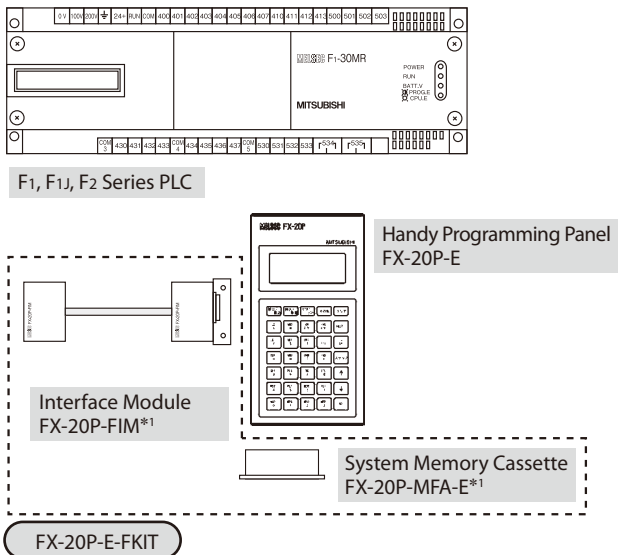

Connect the FX-20P-E-FKIT

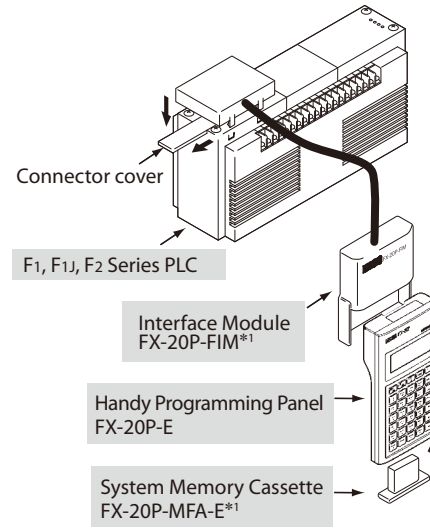

*1: FX-20P-FIM and FX-20P-MFA-E are included with the FX-20P-E-FKIT.

Difference between F1, F1J, F2 and FX3G, FX1S

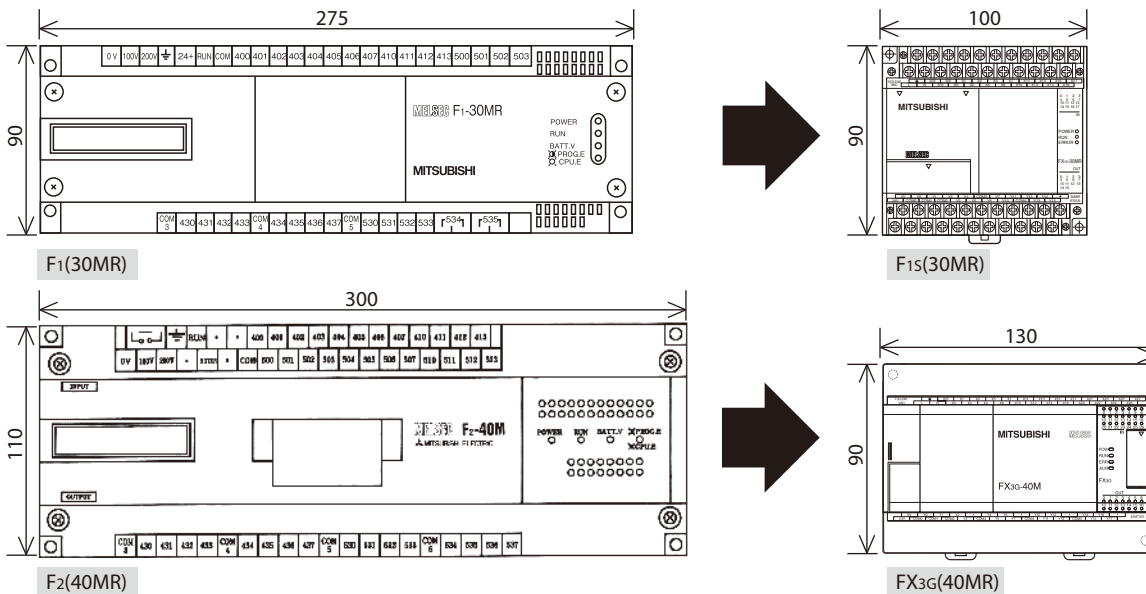

Note: Please refer to the [F1, F2 Replacement Guide] for further details on upgrading F1 and F2 PLCs.

Repair Period
Ended
June, 2009



FX FX2 FX2C FX1

FX, FX2, FX2C, FX1 series PLC renewal

The following steps will guide you through the renewal process for FX, FX2, FX2C, and FX1 PLCs:

1. Connect the FX, FX2, or FX2C or FX1 PLC to a PC using the RS-232C/RS-422 converter.
2. Upload program data with GX Developer and change the PLC type.
3. Connect the new FX PLC, revise the program, and write it to the PLC.

Note: External dimensions and terminal alignment is differs between PLCs. Make sure to change the wiring and system installation according to the new PLC specifications when upgrading.

Connect to the FX,FX2,FX2C,FX1 series PLC

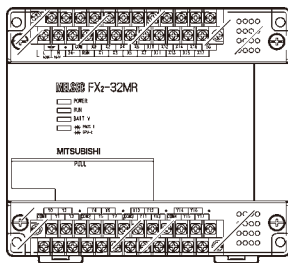

FX, FX2, FX2C, FX1 series PLC

D-SUB 25Pin

RS-422 Cable
FX-422CAB
FX-422CAB-150

RS-232C/RS-422 Interface Converter
FX-232AWC-H



D-SUB 9Pin

RS-232C Cable
F2-232CAB-1

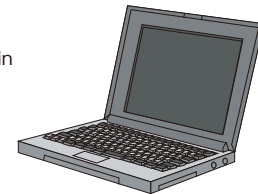

Programming Software
- GX Developer(SW)]D5C-GPPW)

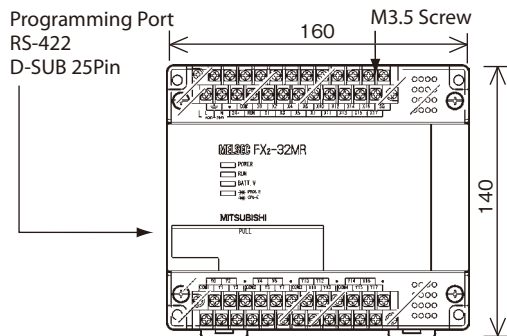

FX, FX2, FX2C, FX1 series PLC

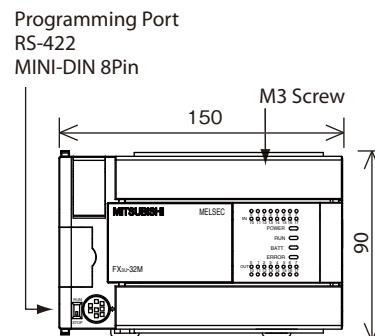

FX3 series PLC

Note: Please refer to the [FX Replacement Guide] for further details on upgrading FX PLCs.

Renewal method for each model

**Repair Period
Ended
June, 2009**



FX0

**Repair Period
Ends January,
2013**



FX0N



FX0S

FX0,FX0N,FX0s Series PLC renewal

The following steps will guide you through the renewal process for FX0, FX0N, and FX0s PLCs:

1. Connect the FX0, FX0N, FX0s PLC to a PC using the FX-USB-AW
2. Upload the program with GX Developer and change the PLC type.
3. Connect the new FX PLC, revise the program, and write it to the PLC

Note: As the external dimensions and terminal alignment is approximately the same between PLCs, the wiring and system installation will have minimal required changes. additional changes. It is always necessary to confirm that PLC is wired and installed correctly, however.

Connect to the FX0, FX0N, FX0s PLC

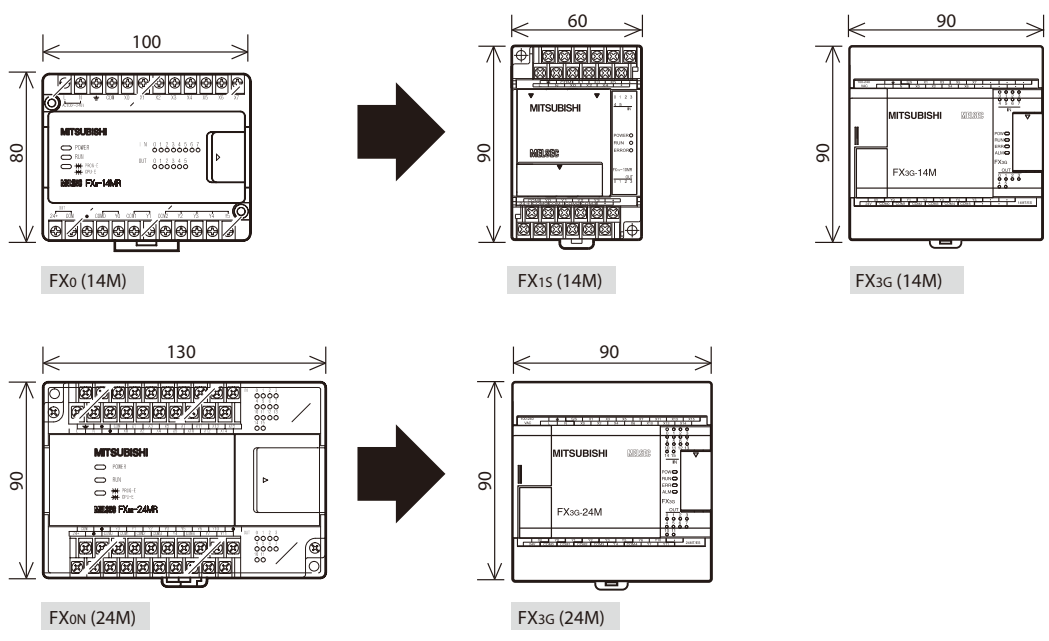
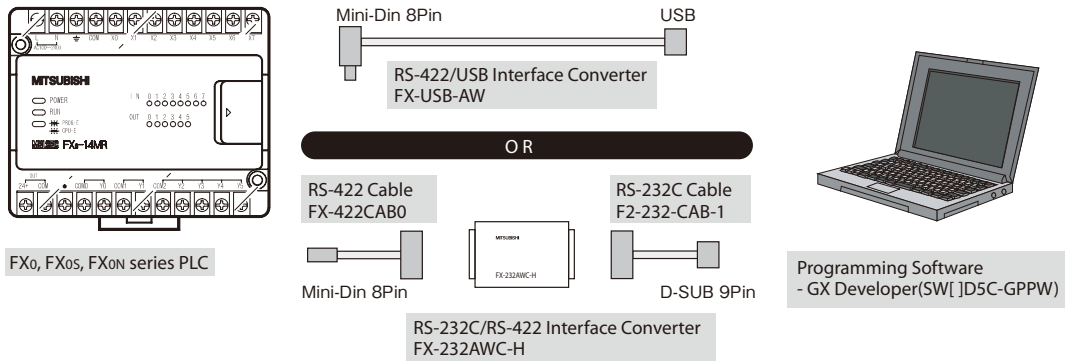

Note: Please refer to the [FX Replacement Guide] for further details on upgrading FX PLCs.

Helpful software aids renewal



Programming Software GX Developer

The key to any good software is that it is simple to use and intuitive. The GX Developer PLC programming package has achieved this by using a design that is easy to understand yet has access to powerful functions and tools. It also features help functions and an advanced communications setup utility, ensuring safe, reliable data transfer to and from the target PLC.

Simulation packages GX Simulator & GT Simulator 3

To save production cost, application designers are expected to reduce program development time. In order to meet this challenge, Mitsubishi Electric has created simulation packages to help designers increase development efficiency.

GX Simulator and GT Simulator allow users to create a virtual PLC or GOT respectively on their PC. PLC code and GOT programs can be tested and any errors debugged without the need of hardware. GX Simulator and GT Simulator have been developed so they can operate simultaneously, allowing a complete application environment to be created within the user's PC.

Screen Design Software GT Works 3

The all new GT Works3 is the most advanced screen design environment.

Experience the dawn of new era in visualization design to quickly transform the front end of your machine into a more user friendly and sophisticated interface you need a design environment that is both intuitive and efficient. GT Works3 is the quintessential environment for visual design and configuration. User-oriented functions are integrated based on three main concepts - simplicity, definition and ease of use. Screen development time is reduced up to 70% compared to other conventional HMI environments.*1

*1: Compared to GT Designer (based on our measurements)

Increase efficiency with Handy Programming Panels!

The FX-30P handy programming panel (HPP) is useful for retrieving program data before PLC renewal and can insert additional functions as well. Flash memory backs up program data, allowing for the freedom to perform program reading at the site and program modification on site or back at the office.*2

FX series PLC data can be modified and the PLC type changed in the FX-30P.*3

*2: The battery lifespan is approximately 5 years (at an ambient temperature of 25°C)

*3: Please refer to section 6.2.6 of the FX-30P Operation Manual (JY997D34301) for details on changing the program data PLC type

The FX-30P Handy Programming Panel

This unit can perform program uploads/downloads and store up to 15 programs in its internal memory. Keyword scan be registered, deleted or canceled in applicable PLCs.

- Compatible with all FX series PLCs.
- Max. 21 characters × 8 lines.
- Store up to 15 programs.
- Program monitoring function is available.
- Connect the HPP to a PC and Upload, Download, and Verify programs in GX Developer(Ver. 1.10 or later).
- The latest firmware can be download via the internet and installed via the USB port.

The FX-30P has equal or greater functionality than the FX-20P-E for all of the functions mentioned above. The FX-20P-E-FKIT only supports the FX-20P-E HPP.



List Monitor Screen

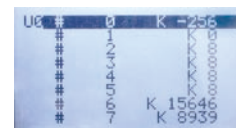

Buffer Memory Monitor Screen



Cables for connection to FX PLCs

- FX, FX1, FX2, FX2c Series PLCs: RS-422 Cable FX-20P-CAB*4
- FX0, FX0s, FX0N Series PLCs: RS-422 Cable FX-20P-CAB0*5
- FX3 Series PLCs: RS-422 Cable FX-20P-CAB0*5

*4: The FX-20P-CAB is not included with the FX-30P. Please acquire it separately.

*5: The FX-20P-CAB0 is included with the FX-30P.

Visualization

GRAPHIC OPERATION TERMINAL
GOT1000

Industrial control panels are increasingly turning into multifunctional human-machine interfaces.

The GOT1000 family features 3 different series to provide the best fit of functionality for all kind of user requirements.

GT16

The all-in-one model

Multimedia Video RGB Network
Backup/restore Serial



15-inch XGA TFT
GT1695M 65,536 colors



12.1-inch SVGA TFT
GT1685M 65,536 colors



10.4-inch SVGA VGA TFT
GT1675M 65,536 colors



8.4-inch SVGA VGA TFT
GT1665M 65,536 colors

GT11

Standard functions for demanding users

Hand health Scripting Parts movement
System monitor

5.7-inch



QVGA TFT
GT1155 256 colors



QVGA STN
GT1155 256 colors



QVGA STN
GT1150 16 gray scales



QVGA Handy GOT/STN
GT1155HS 256 color
GT1150HS 16 gray scales

GT10

Affordability with basic functionality

Multi-language Multi action switch Recipe functions



QVGA STN
GT1055 256 colors
GT1050 16 blue scales



QVGA STN
GT1045 256 colors
GT1040 16 blue scales



STN GT1030
Monochrome Tricolor LED
[Green/Orange/Red] [White/Pink/Red]
Black Frame / White Frame



STN GT1020
Monochrome Tricolor LED
[Green/Orange/Red] [White/Pink/Red]
Black Frame / White Frame

Global Partner. Local Friend. Worldwide Mitsubishi Electric Sales Offices

Australia Mitsubishi Electric Australia Pty. Ltd.
348 Victoria Road, Rydalmere, N.S.W 2116, Australia
Tel: +61-2-9684-7777 Fax: +61-2-9684-7245

Brazil MELCO-TEC Rep. Com.e Assessoria Tecnica Ltda.
Rua Correia Dias, 184, Edificio Paraiso Trade Center-8 ander Paraiso, Sao Paulo, SP Brasil
Tel: +55-11-5511-3146-2200 Fax: +55-11-5511-3146-2217

China Mitsubishi Electric Automation (Shanghai) Ltd.
17/F., ChuangXing Financial Center, No.288 West Nanjing Road, Shanghai, 200003, P.R.C
Tel: +86 (21) 2322-3030 Fax: +86 (21) 2322-3000

Czech Mitsubishi Electric Europe B.V. - o.s. Czech Branch
Radlická 714/113a 158 00 Praha 5 Czech Republic
Tel: +420 251 551 470 Fax: +420 251 551 471

France Mitsubishi Electric Europe B.V. French Branch
25, Boulevard des Bouvets, F-927 41 Nanterre Cedex, France
Tel: +33-1-55 6855 68 Fax: +33-1- 55 68 57 57

Germany Mitsubishi Electric Europe B.V. German Branch
Gothaer Strasse 8 D-40880 Ratingen, GERMANY
Tel: +49-2102-486-0 Fax: +49-2102-486-1120

India Messung Systems Pvt. Ltd.
Electronic Sadan NO:III Unit No15, M.I.D.C. Bhosari, Pune-411026, India
Tel: +91-20-27 12-3130 Fax: +91-20-27 12-8108

Indonesia P.T. Autoteknindo SUMBER MAKMUR
Murara Karang Selatan, Block A/ Utara No.1 Kav. No.11 Kawasan Industri Pergudangan, Jakarta - Utara 14440, P.O. Box 5045 Jakarta, 11050 Indonesia
Tel: +62-21-6630833 Fax: +62-21-66300832

Ireland Mitsubishi Electric Europe B.V. Irish Branch
Westgate Business Park, Ballymount IRL-Dublin 24
Tel: + 353 1 / 4198800 Fax: + 353 1 / 4198890

Italy Mitsubishi Electric Europe B.V. Italian Branch
Centro Dir. Colleoni, Pal. Perseo-Ingr.2 Via Paracelso 12, I-20041 Agrate Brianza Milano, Italy
Tel: +39-039-6053-1 Fax: +39-039-6053-312

Korea Mitsubishi Electric Autoamtion Korea Co., Ltd.
1480-6, Gayang-dong, Gangseo-ku Seoul 157 -200, Korea
Tel: +82-2-3660-9552 Fax: +82-2-3664-8372

Poland Mitsubishi Electric Europe B.V. Polish Branch
ul. Krakowska 50 32-083 Balice, Poland
Tel: +48 12 630 47 00 Fax: +48 12 630 47 01

Russia Mitsubishi Electric Europe B.V.
Moscow Representative Office,
52 /5 Kosmodamianskaya. nab., 115054, Moscow, Russia
Tel: +7-812-633-3497 Fax: +8-812-633-3499

Singapore Mitsubishi Electric Asia Pte, Ltd.
307 Alexandra Road #05-01/02 Mitsubishi Electric Building, Singapore 1599 43
Tel: +65-6470-2460 Fax: +65-6476-7439

South Africa Circuit Breaker Industries Ltd.
Private Bag 2016, ZA-1600 Isando, South Africa
Tel: +27 -11-92 8-2000 Fax: +27-11-392-2354

Spain Mitsubishi Electric Europe B.V. Spanish Branch
Carretera de Rubi 76-80, E-08190 Sant Cugat del Valles, Barcelona, Spain
Tel: +34-93-565-3131 Fax: +34-93-589-1579

Taiwan Setsuyo Enterprise Co., Ltd.
6F No.105 Wu Kung 3rd RD, Wu-Ku Hsiang, Taipei Hsien, Taiwan
Tel: +886-2-2299-2499 Fax: +886-2-2299-2509

Thailand Mitsubishi Electric Automation (Thailand) Co., Ltd.
Bang-Chan Industrial Estate No.111 Moo 4, Serithai Rd, T.Kannayao, A.Kannayao, Bangkok 10230 Thailand
Tel: +66-2-517-1326 Fax: +66-2-517-3239

U.K. Mitsubishi Electric Europe B.V. UK Branch
Travellers Lane, Hatfield, Hertfordshire., AL10 8XB, U.K.
Tel: +44-1707-27 6100 Fax: +44-1707-27 8695

U.S.A. Mitsubishi Electric Automation, Inc.
500 Corporate Woods Parkway, Vernon Hills, IL60061, U.S.A.
Tel: +1-847-478-2100 Fax: +1-847-478-0327



MITSUBISHI ELECTRIC CORPORATION

HEAD OFFICE: TOKYO BLDG., 2-7-3, MARUNOUCHI, CHIYODA-KU, TOKYO 100-8310, JAPAN
<http://Global.MitsubishiElectric.com>